

zFrog IoT Thing Board (CR-IOT-AT100) Image Write Guide

CRZ.

CRZ. TECHNOLOGY

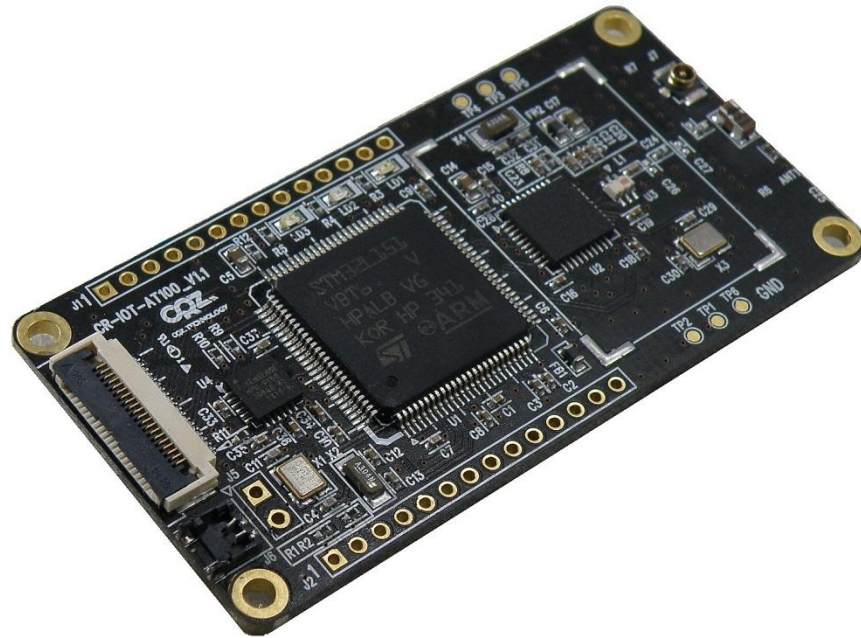

zFrog IoT Thing Board (CR-IOT-AT100)

How to get an image

1 Download image

[click](#)

2 Unzip the file

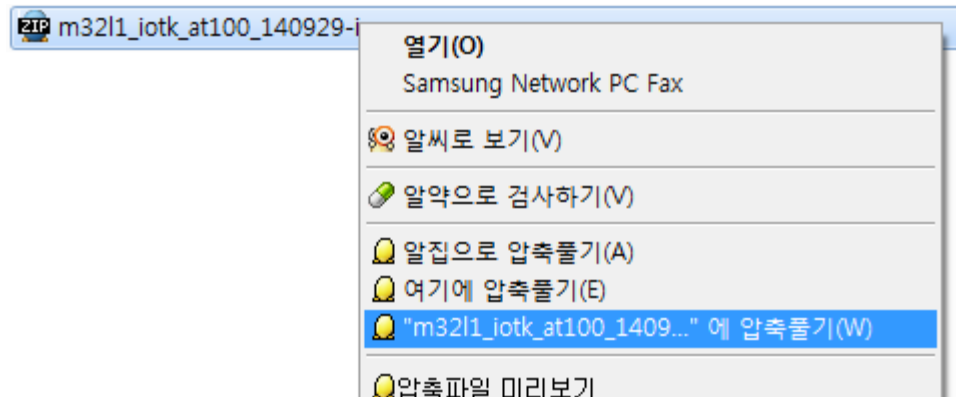

Necessary equipment

- ❖ Boards : [zFrog IoT Thing Board \(CR-IOT-AT100\)](#) , [CR-IOT-ATBG1](#), [CM-CC-DEBUGGER](#), [RS-232 모듈](#),
- ❖ Cables : [20Pin Ribbon Flex Cable](#) , [mini-usb Cable](#) , [10 Pin Flat Ribbon Cable](#)
- ❖ Power Supply : [5V /2A adapter](#)



switch settings for downloading

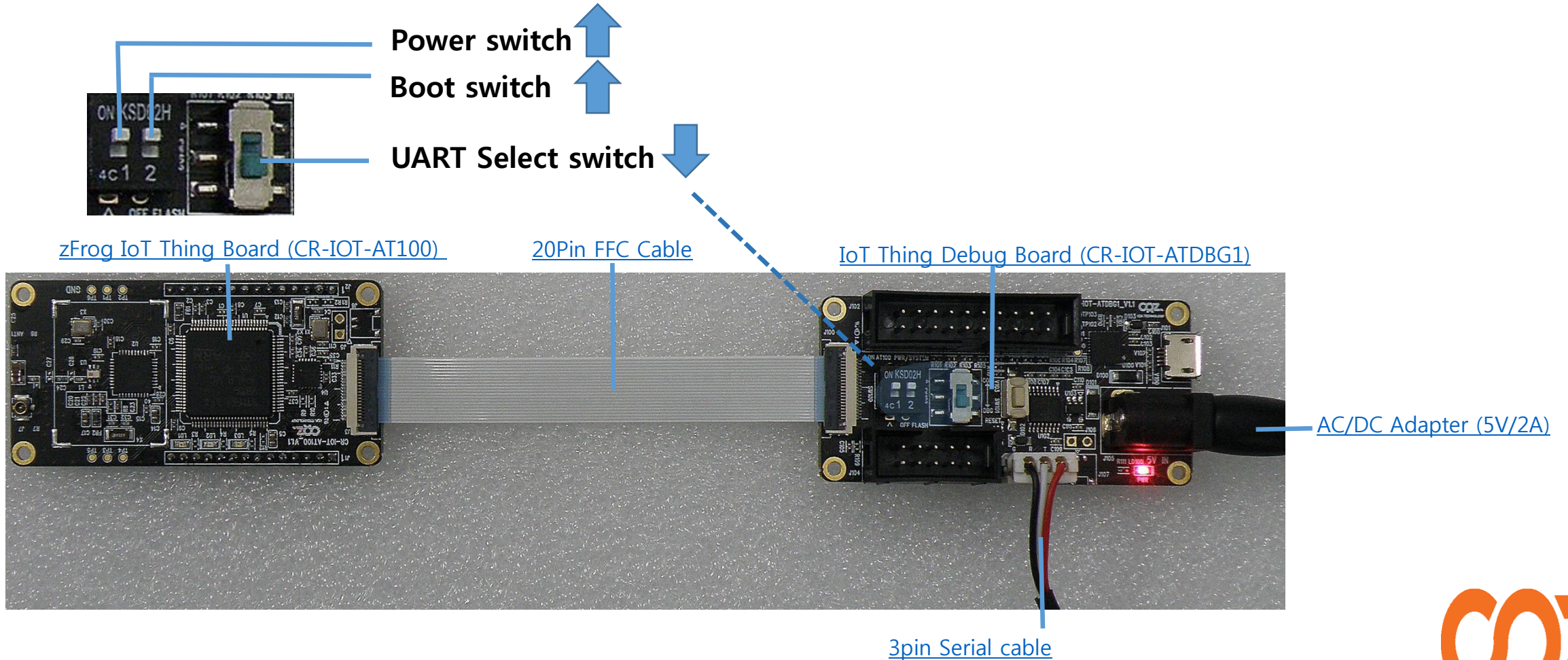

How to Install STM32 Flash Loader Demo

1 Download Setup file (Flash Loader Demonstrator 2.6)

[Link](#)

2 Install on PC



How to Download

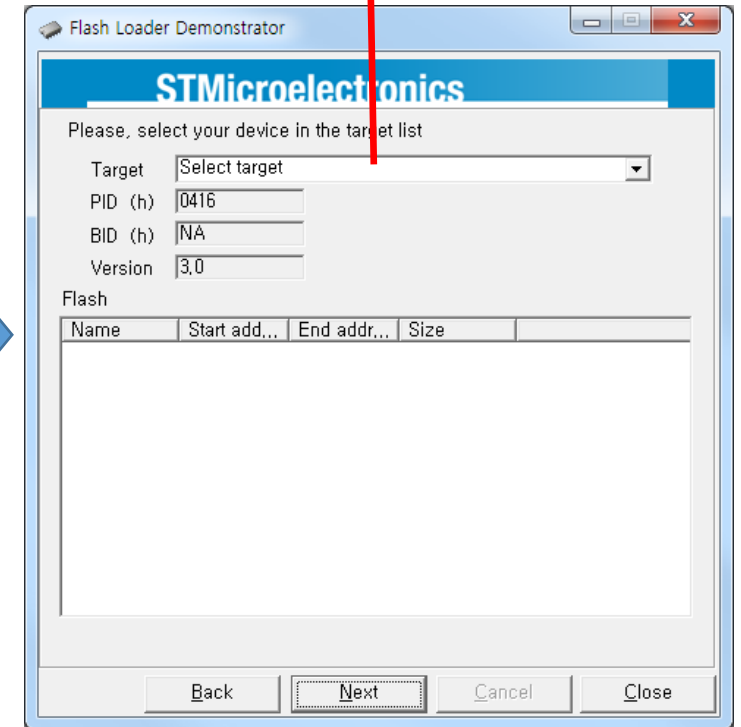
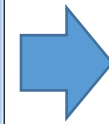
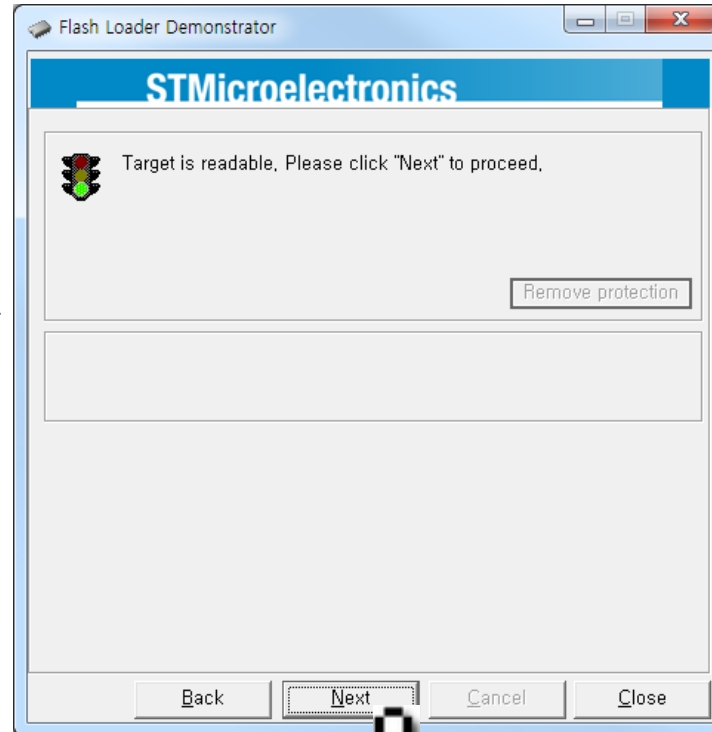
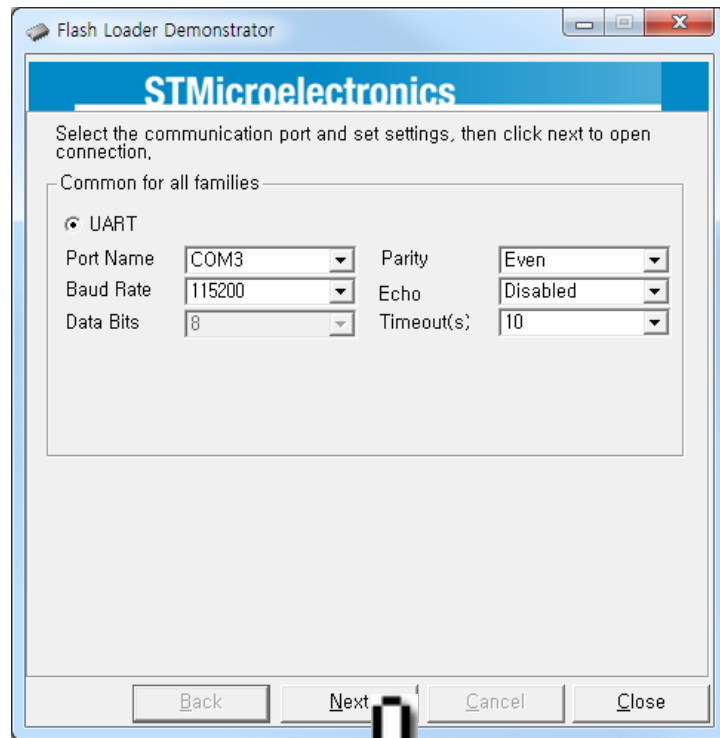

Change the target to
"STM32L_Med-densiy-128K "



How to Download

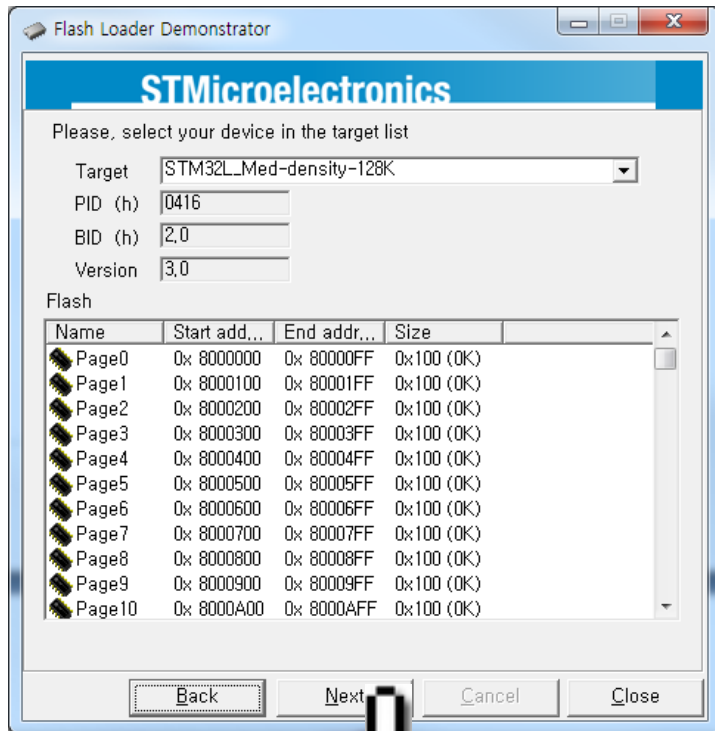

Select to the download file

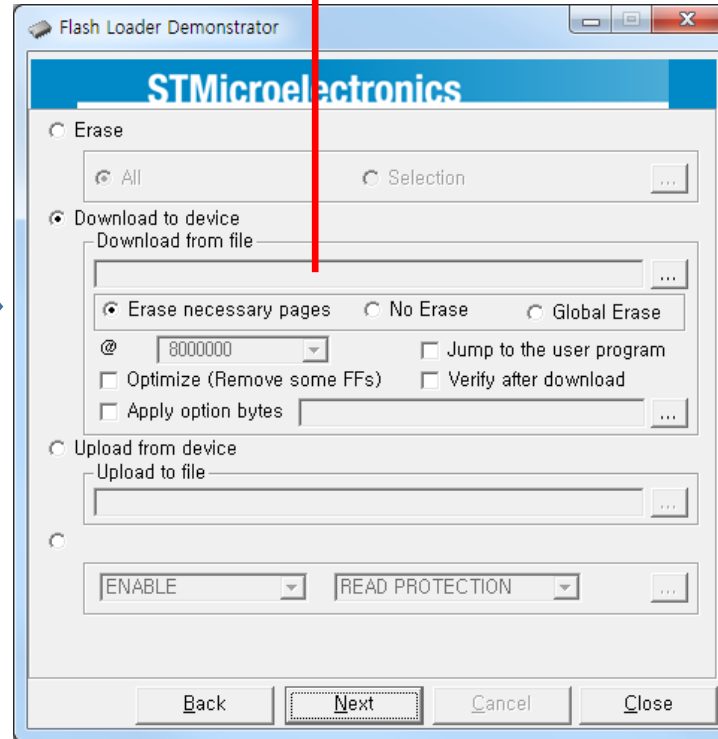

Open

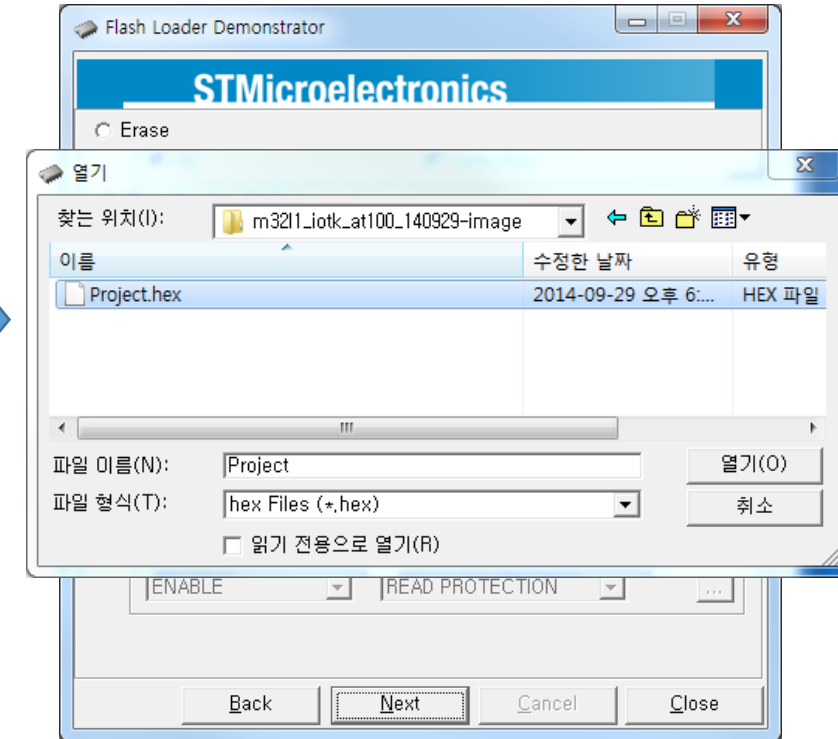

How to Download

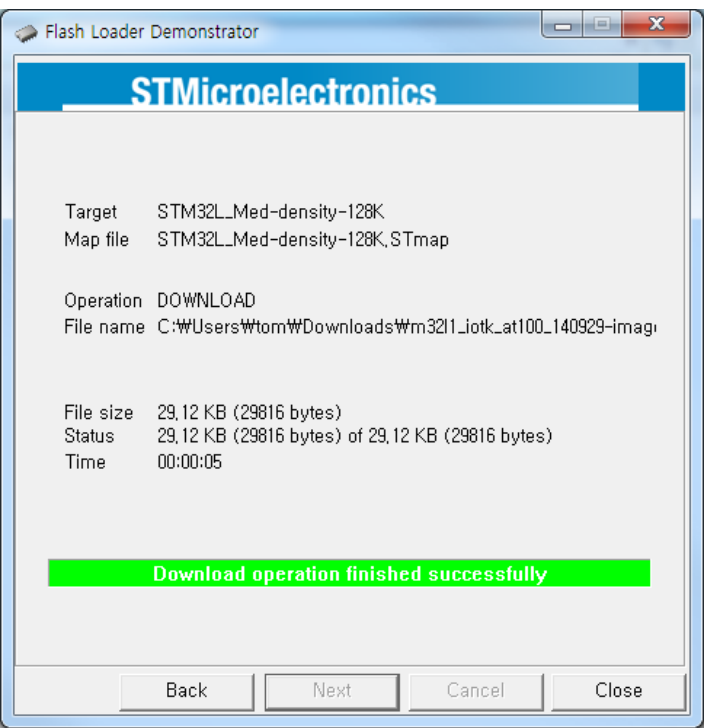
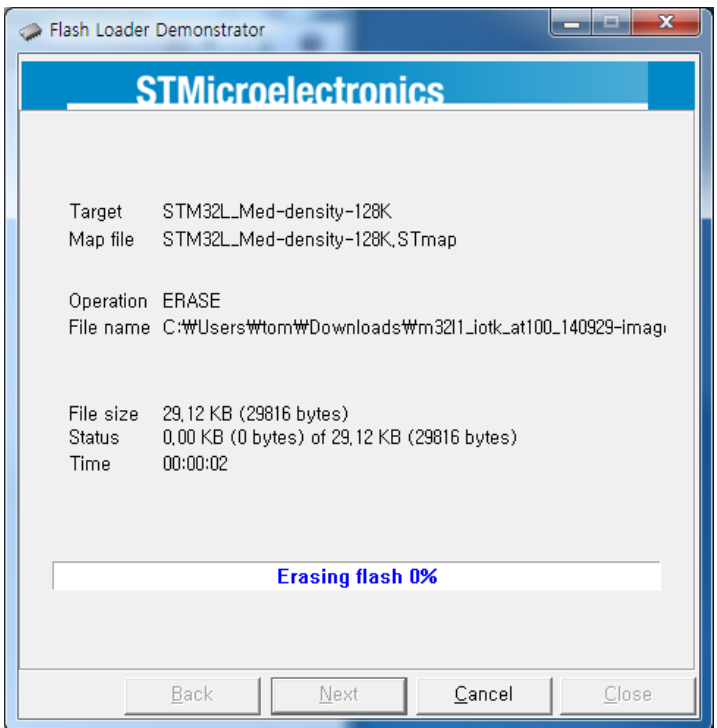
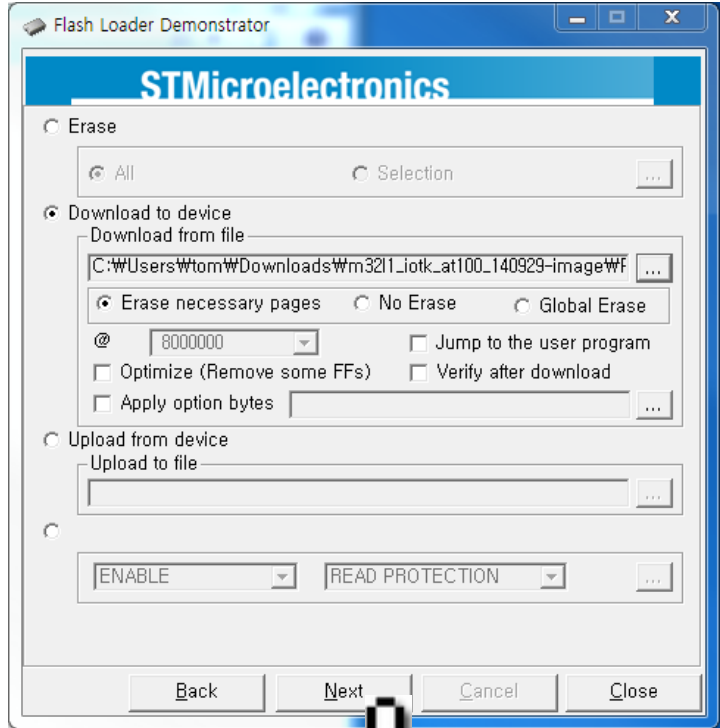

Related Guide

- ❖ [Quick Start Guide zFrog IoT Thing Board \(CR-IOT-AT100\)](#)
- ❖ [적외선 감지 센서와 zFrog IoT Thing Board\(CR-IOT-AT100\) 이용한 침입 감지 시스템](#)
- ❖ [zFrog IoT Thing Board ZigBee 통신 Test Guide](#)





For more information , visit
<http://www.mangoboard.com>
<http://cafe.naver.com/embeddedcrazyboys>